

**Guaranteed Performance
Results Underwritten**

McCloskey INTERNATIONAL

B200

Bivitec Screens start where others fail

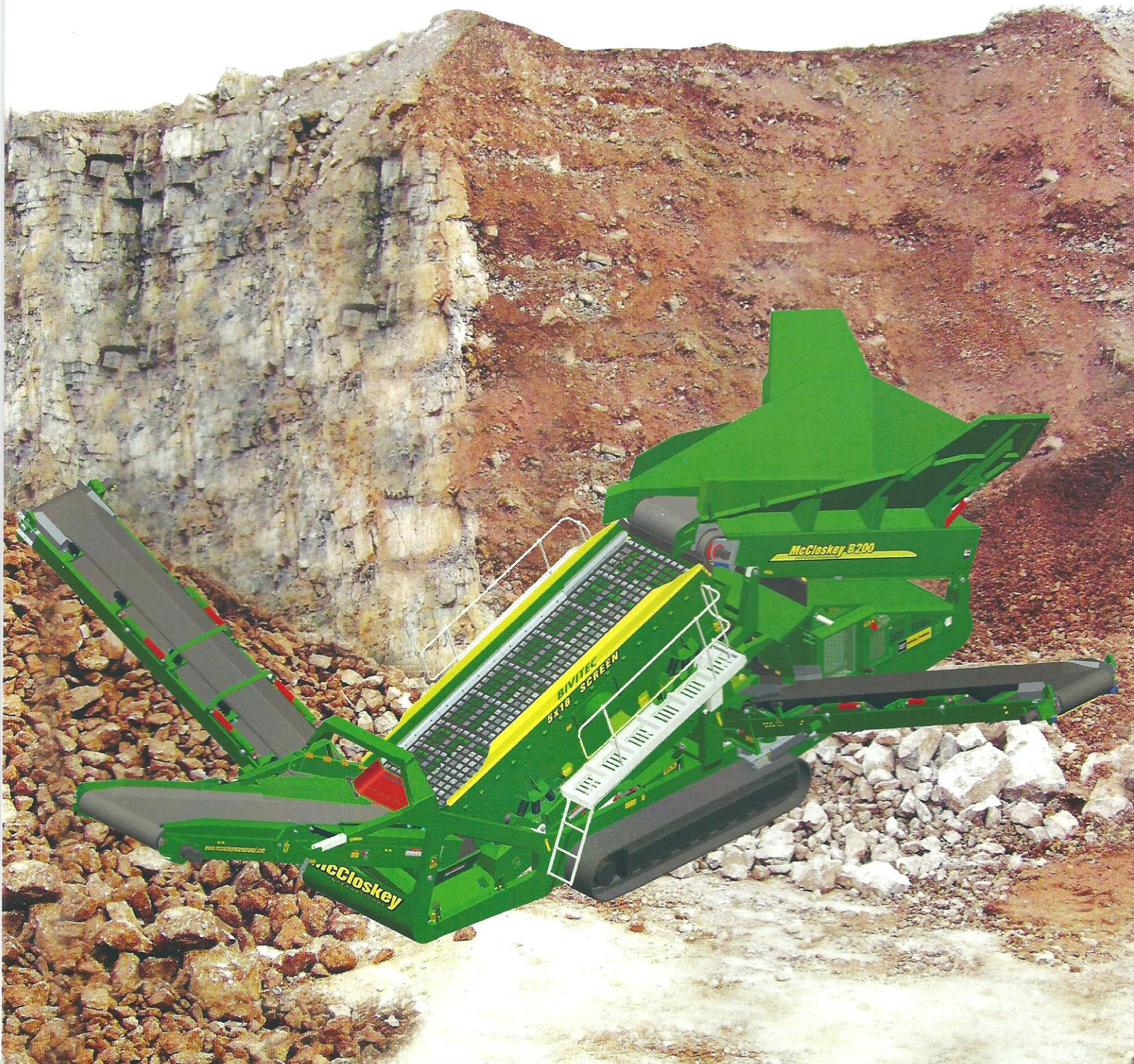

B200

High G Force Screener

With the largest screenbox and hopper in its class, the B200 will accommodate the stickiest of applications at the highest production efficiency

"McCloskey machines are outstanding and the best company I have ever worked with. With the Binder Bivitec box now an option, this specialist machine is certainly in a class of its own. It must be the market leader in fine screening".

Ronan Ghosh, Managing Director, RG Recycling Limited, London, UK

Options



Hopper extension wing plates

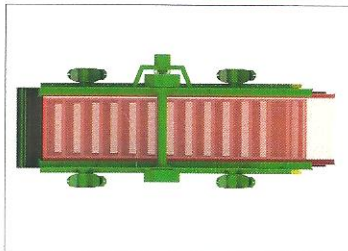

Specialist BIVITEC High G Force Screen

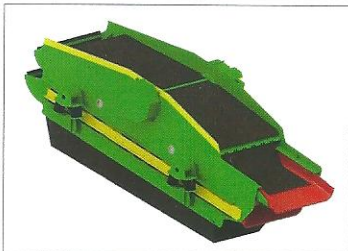

Single or 2 deck screen

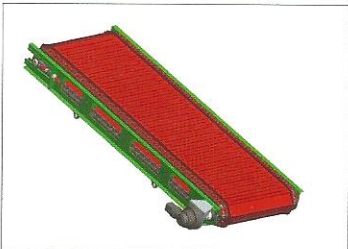

Hardox plate feeder

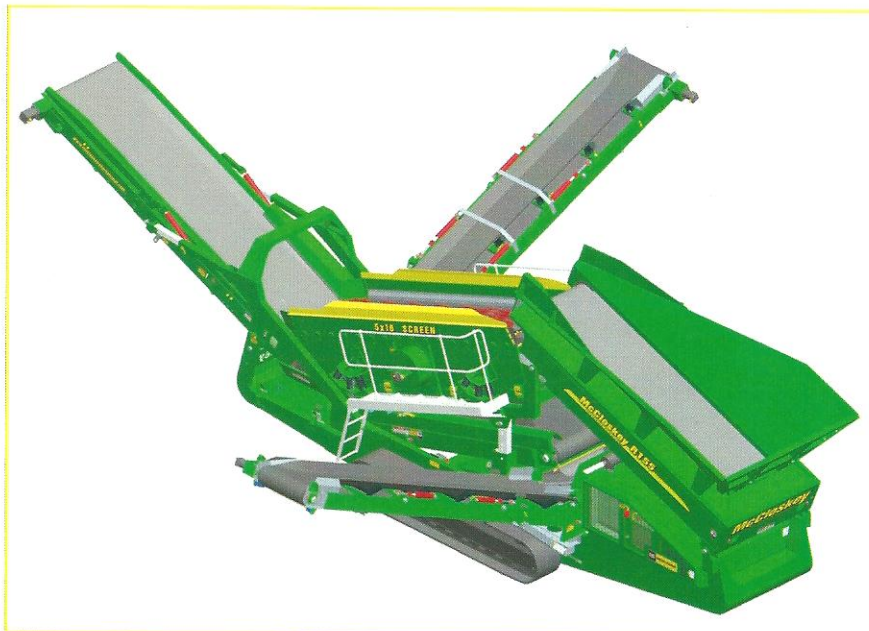

Features & benefits

Wide chutes -
Optimal chute design minimises potential material spillage and blockages

High energy 16x5 (4880x1525mm) screenbox -
Provides highest product capacity in its class

Wide feed opening -
Allows for free flow of material and high volume capacity

Large loading area -
A significantly longer and wider hopper provides the largest loading area in its class

Heavy duty build -
One of the most robust and durable machines on the market, with a weight of 36,500kg



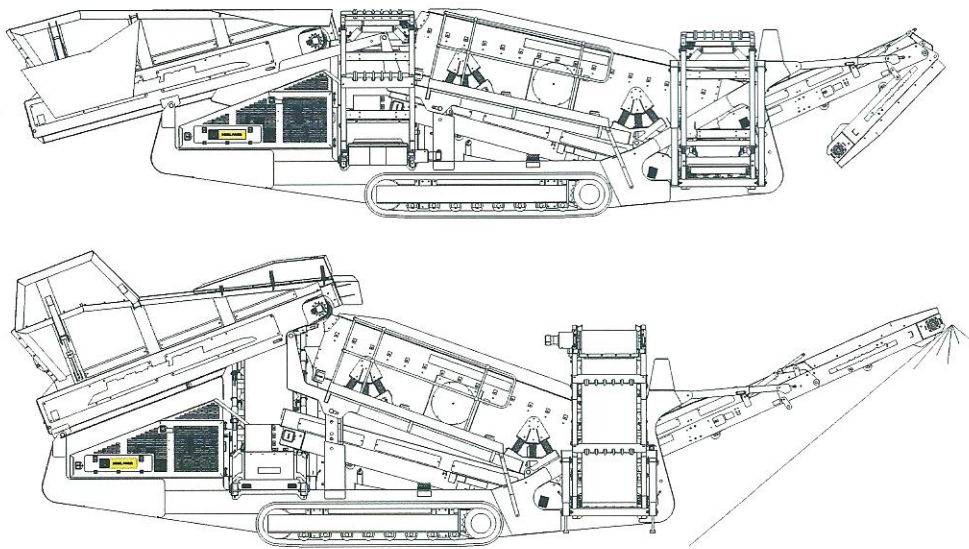

B200 Dimensions and weight

Length - working	15.21m	49'10"
Width - working	13.45m	44'1"
Length - transport	15.30m	50'2"
Width - transport	2.90m	9'6"
Height - transport	3.40m	11'2"
Weight - transport	36,500kg	80,469lbs estimated

See it in action...

View working videos, customer testimonials and more at

www.mccloskeyinternational.com

McCloskey
INTERNATIONAL

N. America & S. America

#1 McCloskey Road, RR#7
Peterborough, Ontario, Canada
K9J 6XB

1-877-Trommel
T (705) 295-4925
F (705) 295 4777

mccloskey@mccloskeyinternational.com

UK & International

McCloskey Equipment Limited
Upper Farm Road, Chilton, Didcot
Oxfordshire OX11 0PJ

T +44(0)1235 832407
F +44(0)1235 821595

www.mccloskeyequipment.co.uk
noel@mccloskeyequipment.com

McCloskey International reserves the right to make changes to the information and design of the machines on this brochure without reservation and notification to the users. McCloskey International assumes no liability resulting from errors or omissions in this document.

Standard Features



Durability

Branded components throughout - CAT engine, David Brown Pumps, 2 pack Paint system

Heavy duty Hardox steel

High efficiency diesel hydraulic system allows higher throughput and lower fuel consumption



Maintenance/User friendly

Accessible engine bays

Fixed galvanised walkways

Universal user friendly controls throughout the McCloskey line

10 min set up time

Highly maneuverable onsite

Unique user friendly belt adjusters

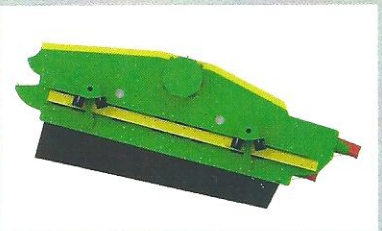

Authorised dealer